



4PPOE CABLING REQUIREMENTS

GETTING READY
FOR THE FUTURE
OF TWISTED PAIR



DINTEK POWERMAX



DINTEK
LAN CABLING SYSTEMS

With the advent of 4PPoE Power over Ethernet delivering up to 100w of available power to end of line devices, one thing has become abundantly clear. The impression that copper is dead is far from the truth.

Twisted pair cabling has an interesting future ahead, not just as a way to connect PC's to servers, but it will be used to supply lighting systems, power commercial equipment, industrial devices and even connect to domestic appliances.

The following cabling brochure outlines the fundamentals of PoE its evolution, where it is heading, what that means for data cabling installations and the DINTEK 4PPoE rated products available to provide for this new revolution in cabling services.

TABLE OF CONTENTS

- The evolution of PoE & Powering Remotely..... 3
- IEEE 802.3bt (4PPoE) What's the fuss about..... 4
- What are the future applications of PoE..... 4
- The Advantages of PoE & Twisted Pair cabling..... 4
- DINTEK deployment considerations for 4PPoE..... 4
- Specific factors to consider when deploying cabling..... 5
- DINTEK requirements for design and installation..... 5
- Standard cabling topologies in buildings..... 6
- Equipment rooms and specific PoE requirements..... 6
- Telecommunications Rooms Considerations..... 6
- Horizontal Cabling Considerations..... 7
- Pathway systems & Conduit..... 8
- Assessing & Calculating larger bundling sizes..... 9
- Why 4PPoE Type 4 product compliance is so important..... 10
- DINTEK Cat6 & Cat.6A 4PPoE Ready Cable Solutions..... 11
- DINTEK Cat6 & Cat.6A 4PPoE Ready Connector Solutions..... 12
- Completing The Channel (Patch Cords & Plugs)..... 14
- Product Placement For End To End Performance..... 15

The evolution of PoE & Powering Remotely

Power over Ethernet (PoE) is a technology for wired Ethernet local area networks (LANs) that allows the electrical current necessary for the operation of each device to be carried by the data cables rather than by power cords. Doing so minimizes the number of wires that must be strung in order to install the network. PoE was originally developed in 2003 to support devices like Wi-Fi access points (APs). PoE made AP installations easier and more flexible, especially on ceilings.

For PoE to work, the electrical current must go into the data cable at the power-supply end, and come out at the device end, in such a way that the current is kept separate from the data signal so that neither interferes with the other. The current enters the cable by means of a component called an injector. If the device at the other end of the cable is PoE compatible, then that device will function properly without modification. If the device is not PoE compatible, then a component called a picker (or tap) must be installed to remove the current from the cable. This “picked-off” current is routed to the power jack.

Equipment built to the 2003 standard initially delivered enough power for most APs, but could not provide enough power for other types of mounted technology, such as video surveillance cameras. Over the years, the Institute of Electrical and Electronics Engineers (IEEE) and several vendors have attempted to address the power issue, but there have always been problems with interoperability.

The IEEE has of course now solved this problem by releasing a new standard that supplies power through all four wire pairs in a twisted 4 pair cable.

“ 4PPoE or IEEE 802.3bt is also known as Next Generation PoE..... ”

IEEE 802.3BT 4PPoE

WHAT IS ALL THE FUSS ABOUT?

As Power over Ethernet (PoE) continues to grow in popularity, so does the demand for applications with higher power. The introduction of the new PoE standard IEEE 802.3bt, meets this demand by doubling or perhaps as much as tripling the amount of power delivered to the end device. The previous standard enabled power transmission over just two pairs of a four-pair cable, whereas the new standard takes advantage of all four pairs, spreading the flow and allowing up to 100W of power transmitted.

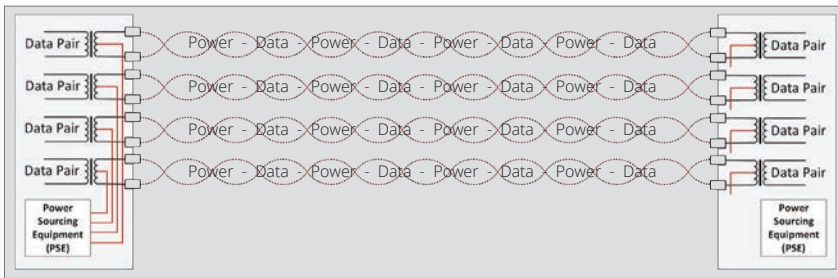

THE ADVANTAGES OF POE & TWISTED PAIR CABLING

PoE's application base will increase enormously with the increase of power to the end device. The main advantage for design engineers is based mostly on the saving in installation costs through the delivery of power and data on the same link compared to running on separate lines. This makes the installation and relocation of devices as simple as moving a standard CAT5/6 cable, instead of requiring an electrician to move ac power sources. Devices can be remotely powered down during periods of low usage or for security purposes

ADVANTAGES OF POE INCLUDE

- Installation Cost Savings
- Eliminates the need for electrical outlet installation
- Dramatically reduces cost of deployment
- Simplifies Installation
- Uses a single Cat 5e/6/6A cable for both data and power
- Centralized Power Backup
- Continuous operation during power interruptions
- Centralized Power Management
- Devices can be remotely powered down during periods of low usage
- SAFE Power
- Will not damage Non-PoE devices or legacy peripherals
- Cables de-power upon disconnection from end devices

DEPLOYMENT CONSIDERATIONS FOR 4PPOE

TIA 569.D-2 Additional pathway & space considerations for supporting remote powering over balanced twisted-pair cabling

CENELEC CLC/TR 50174-99-1 Information technology Cabling installation Part 99-1: Remote powering

ISO/IEC 14763-2 revision including remote power planning & installation is in development

ISO/IEC TS 29125 Information Technology Telecommunications Cabling Requirements For Remote Powering Of Terminal Equipment

TIA TSB 184-A Guidelines for Supporting Power Delivery Over Balanced Twisted-Pair Cabling

Standards development organizations for cabling infrastructure like TIA, ISO/IEC, CENELEC, and NEC have published/developing specifications with design, installation and operational guidelines to allow for reliable deployment of remote powering networks, including PoE.

The documents used within this brochure are the source of many of the guidelines included in these implementation standards.

The guidelines in the standards listed above include the max. current carrying capacity of twisted pair cables used in commercial buildings under various installation conditions and ambient temperatures.

Following these standards allow the infrastructure to be designed, installed and maintained to optimize the electrical and thermal performance under various configurations.

The guidelines support delivery of power using all four pairs with up to 1000 mA per pair (500 mA per conductor) for a maximum power of 100 VA (100 watts) at the power source over four-pair cabling, assuming a nominal 50 V power supply at the PSE.

Moreover, in order to improve the consistency of installation practices, the proposed IEC 60364-7-716 (a new standard used as a reference document in many international electrical codes) states that if telecommunication cabling is to be used for power delivery it shall be planned and installed in accordance with ISO/IEC 14763-2 or CENELEC EN 50174 series.

SPECIFIC FACTORS TO CONSIDER

WHEN DEPLOYING CABLING

WHEN DESIGNING OR DEPLOYING TWISTED PAIR CABLING FOR 4PPOE THERE ARE SPECIFIC FACTORS THAT THE INSTALLER SHOULD TAKE INTO CONSIDERATION. FAILURE TO OBSERVE THESE CAN CAUSE ISSUES WITH SAFETY AND PERFORMANCE.

- The Type Of Cables That Are To Be Installed
- The Type Of Patch Cords, & Rj45 Connectors
- Pathway Infrastructure Types Used For Supporting The Cables
- The Amount And Configuration Of Cable Bundles
- Specific Length Of Cable Routes



REQUIREMENTS FOR DESIGN AND INSTALLATION

The recommendation from DINTEK for a reliable and high performing installation that will support 802.3bt remote powering is to use an overall approach covering all aspects and including the following:

- Type of twisted pair cable; metallic makeup, wire gauge and category type
- Up to date installation practices including use of 4PPoE rated connectors
- Types of cabling pathways employed and cable distances
- Adherence to administration requirement depending on LAN size



CABLING TYPE - THE BEST PLACE TO START

When considering the cabling type, it is best to allow for the cabling system to accommodate the new standard 802.3bt. As intelligent LED lighting, home automation, intelligent businesses, PoE to the desktop to power all equipment, IoT devices, not to mention the plethora of equipment already in the market space, the need for 100w supply to end equipment is going to be demanded more and more.

Not to have allowed for the cabling to handle the currents and associated generated heat could end up costing the end user a lot in upgrades. Just simply putting in Cat5e and saying it can handle 4PPoE is not enough. While technically possible, the practical reality will prove otherwise.

“ The larger Category of Cable The better... ”

DISTRIBUTION TOPOLOGY

MOST COMMON IN COMMERCIAL BUILDINGS

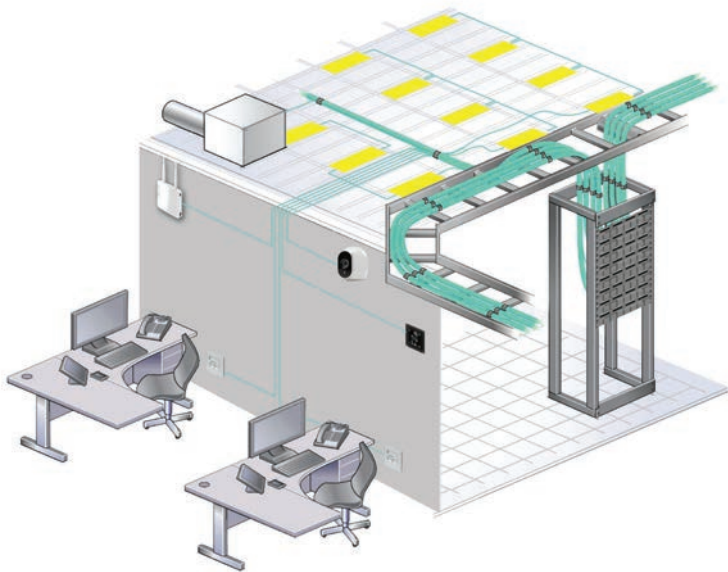

The illustration on the left shows a standard Star Topology used in commercial buildings. This depiction shows the remote powering of many different devices. For installations that will be used for remote powering (4PPoE), the size of cable bundles must be limited in number of cables per bundle. The cable bundles should also not be laid on top of each other or packed tightly. DINTEK advises that bundle sizes be limited to a maximum of 24 cables per bundle. This will allow cables with wire gauge of 24AWG or larger to sit within the standard cable maximum operating temperature rating of 60°C when deployed as a worst-case scenario. For ambient temperature, an ambient temperature of 45°C is considered for both air and conduit.

TELECOMMUNICATIONS & EQUIPMENT ROOMS

Telecommunications & Equipment Rooms are an area of the structured network which tend to have a modest amount of cable reticulation running on various pathway types. Whether the pathway structure is cable tray, trunking or conduits, the adherence to allowing the ability of central cables to be able to dissipate heat easily.

Summary

- Suggested max bundle size is 24
- Organize bundles to avoid stacking and packing to allow air flow
- Cable bundles open to air flow throughout rack space
- 24 cable bundles patch panel exiting on both sides of patch panel

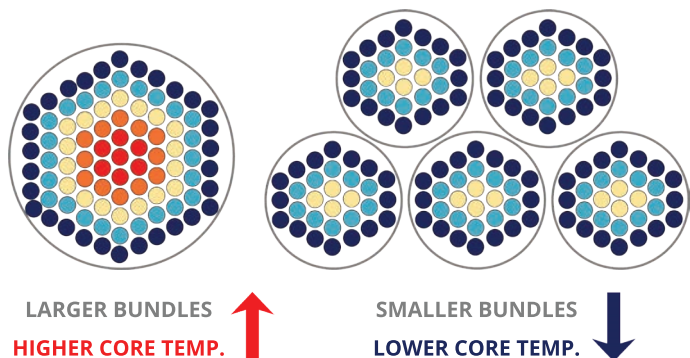
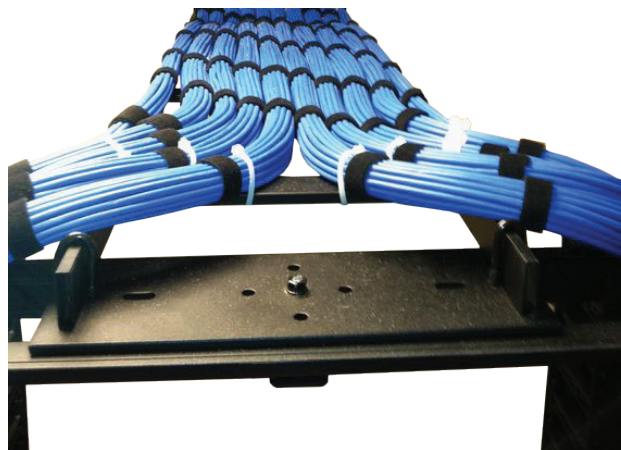

HORIZONTAL CABLING INSTALLATION CONSIDERATIONS

SUITABLE CABLE TYPE TO USE

When choosing the correct cable to use for an installation that will carry 4PPoE there are two main factors to consider. The factor that one is trying to minimize is heat generation within bundles. This can be achieved by two things; cable gauge size and cable shielding. Shielding is an advantage with PoE cabling as the shielding acts as an insulator between different cables, therefore lessening overall heat within the center of the bundle of cables.

INCREASE THE CABLING CATEGORY SIZE

One way to mitigate heat generation in cable bundles is by choosing a higher category or class of cable. This will increase the cross section of the copper conductor and therefore lower the generated heat per cable. Higher cable categories consistently maintain lower temperatures than lower categories.

Let us look at the difference between 23AWG cable (typically Cat6) and 24AWG typically Cat5e. As wire AWG gauge lowers, the cross sectional area increases. Therefore, 23AWG cable core physical size is larger than 24AWG. This means power voltage drop in a 23AWG wire will be smaller than a 24AWG wire. A larger core size also means that the resistance is smaller, resulting in the accumulation of less heat generated and less attenuation over distance core physical size is larger, this means power voltage drop will be smaller than the 24AWG wire

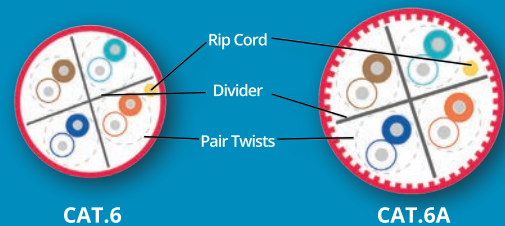

Higher Category Cables Often Comprise

Thicker jackets increasing distance between cables

Larger dividers giving greater distance between wire pairs

Larger wire size reducing heat creation

CONSIDER INSTALLING SHIELDED CABLE

Although more costly, a work around is to install higher shielding cabling for larger cable bundles. Shielded cable will help increase the insulation of your PoE cable bundles.

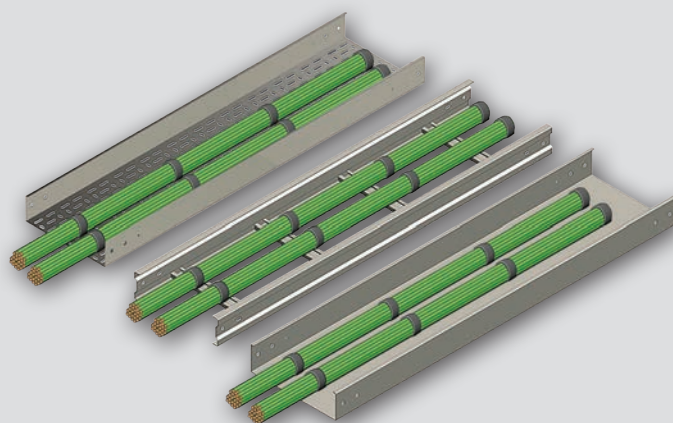
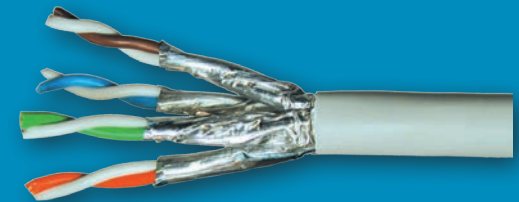

CABLE MANAGEMENT

The design of the horizontal cabling subsystem should configure the cables to allow maximum ventilation by selecting pathway structures that spread the cables over the full width of a pathway or by leaving a reasonable separation between separate bundles.

PATHWAY SYSTEMS & CONDUIT

MOST COMMON IN COMMERCIAL BUILDINGS

“Higher wattages, will cause higher temperatures to be created, and higher temperatures cause reduced performance”

PoE cable bundles generate heat due to the power transmission that occurs through the copper conductors. Cable bundles with higher temperature-ranges are more likely to experience power dissipation. An increase in power dissipation will cause decreased cable ranges. For this reason, cable pathways for 4PPoE deployment are required to be calculated correctly.

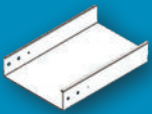

SOLID CABLE TRUNKING

The type of pathway systems used can affect heat dissipation and impact the temperature rise in a cable bundle. When using open or enclosed cable trunking do not fill the cable trunking above 50 percent.

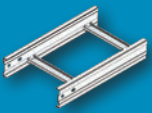
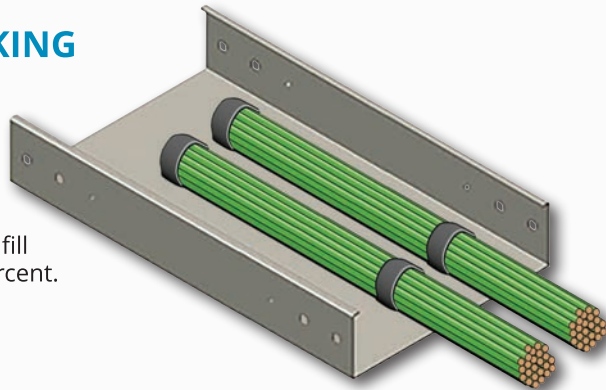

LADDER OR BASKET TRAY

Another type of cable tray pathway system is the ladder tray or wire basket tray. Typically, the ladder or wire basket tray has a lower temperature rise than the solid bottom cable tray because of more air circulation. This can allow for a slightly larger ratio fill.

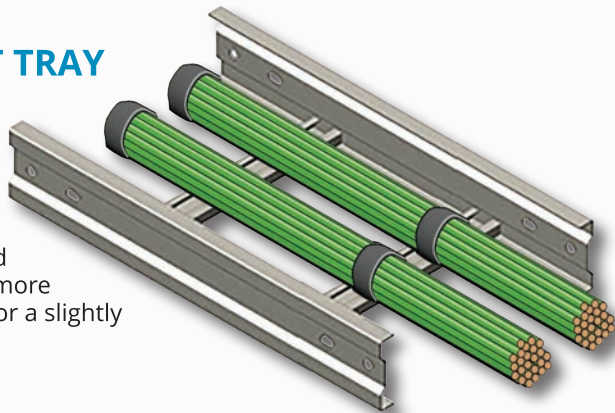

CONDUIT INSTALLATION

Installation in conduit degrades thermal performance—with a higher temperature rise than open-air installation. Conduit installation should be minimized to only those areas mandated by specifications, using a maximum fill percentage of 40 percent and maximum bundle sizes of 24 cables per bundle.



LARGER BUNDLE SIZES

ASSESSING & CALCULATING LARGER BUNDLING SIZES

When in doubt about cable mechanical or heat dissipation capability, installation environment, or remote powering application, a conservative practice is to limit maximum bundle size to 24 cables

The recommended bundle size of 24-cables per bundle is just that, a recommendation. It is not a hard and fast requirement—but as a general rule it should be followed to ensure heat dissipation in cable bundles.

However, sometimes, larger bundle sizes may be required; and it is in these situations that a qualified designer/installer can make the necessary calculations and evaluations to determine if a specific bundle size will cause any overheating.

The TIA, ISO/IEC and CENELEC cabling standards carry appropriate tables on remote powering implementation and provide a process to check if a particular cable category bundle size is acceptable. For a given ambient temperature and installation condition—if the current per pair is greater than the maximum current on the PoE port—the cable bundle size is acceptable. Tables like the one below are utilized when more in depth calculations are required to obtain the current carrying capacities of cables in certain bundle sizes given the gauge size of the cables..

NEC 2017 Code Requirements Article 725 Table 725.144																					
Number of Pair Cables in a Bundle																					
Core Gauge	1			2-7			8-19			20-37			38-61			62-91			92-192		
	Temp Rating			Temp Rating			Temp Rating			Temp Rating			Temp Rating			Temp Rating			Temp Rating		
	60°C	75°C	90°C	60°C	75°C	90°C	60°C	75°C	90°C	60°C	75°C	90°C	60°C	75°C	90°C	60°C	75°C	90°C	60°C	75°C	90°C
26AWG	1.0	1.0	1.0	1.0	1.0	1.0	0.7	0.8	1.0	0.5	0.6	0.7	0.4	0.5	0.6	0.4	0.5	0.6	N/A	N/A	N/A
24AWG	2.0	2.0	2.0	1.0	1.4	1.6	0.8	1.0	1.1	0.6	0.7	0.9	0.5	0.6	0.7	0.4	0.5	0.6	0.3	0.4	0.5
23AWG	2.5	2.5	2.5	1.2	1.5	1.7	0.8	1.1	1.2	0.6	0.8	0.9	0.5	0.7	0.8	0.5	0.7	0.8	0.4	0.5	0.6
22AWG	3.0	3.0	3.0	1.4	1.8	2.1	1.0	1.2	1.4	0.7	0.9	1.1	0.6	0.8	0.9	0.6	0.8	0.9	0.5	0.6	0.7

Note 1: For bundle sizes over 192 cable, or for conductor sizes smaller than 26AWG, ampacities shall be permitted to be determined by qualified personnel under engineering supervision.
 Note 2: Where only half of the conductors in each cable are carrying current, the values in the table shall be permitted to be increased by a factor of 1.4.
 Informational Note: The conductor sizes in data cables in wide-spread use are typically 22-26 AWG.

WIRE TRAYS

Use open wire tray or similar cable management that provides for largely unrestricted airflow around the installed cables

DISPERSION

Disperse cables evenly across the width of the tray. This reduces the stacking of cables on top of each other

TEMPERATURE

Reduce maximum operating temperature, therefore reducing attenuation and increasing performance

MIX CABLING

Mix powered & unpowered cables. The more cables that are powered in a bundle, the greater the central temp. increases.

ADDITIONAL QUESTIONS TO ASK YOURSELF

Look at the Ambient temperature where cable is installed

Do I need to de-rate my maximum channel length ?

Is my maximum cable operating temperature greater than the ambient temperature plus 15°C ?

Cables with 75°C have more flexibility, consider LSZH

What are the maximum bundle sizes for the cable being used ?

Does my connectivity meet IEC 60512-99-002 ?

Is my ambient temperature where my jacks are installed at least 5°C below the maximum jack operating temperature ?

802.3BT TYPE 4 COMPLIANCE

WHY ARE COMPLIANT PRODUCTS SO IMPORTANT

IT'S NOT JUST ABOUT THE CABLING WHEN IT COMES TO 4PPOE

Cable Routing & Cable bundling sizes are not the only considerations to take into account with Type 3 & 4 802.3bt. The connecting hardware (e.g. patch panels, jacks and patch cords) play an equally important part. Higher wattages, will cause higher temperatures to be created when it comes to cabling, but in addition, higher amperage will mean a larger breaking arc on hardware

PoE is not live until the powered device (PD) and powered sourcing equipment (PSE) handshake.

It is for this reason that there is no arc during the initial mating process

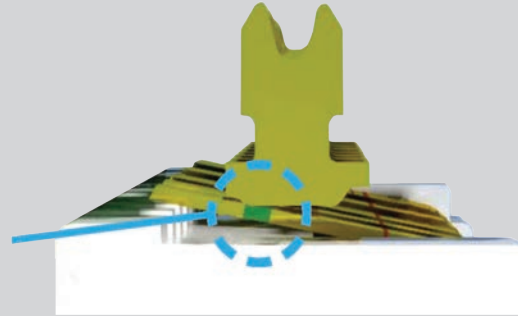

However, when unplugging a live PoE connection, an arc (or spark) occurs between plug and jack contacts. The higher the current i.e. 600mA for 802.3bt Type 3 or 802.3bt Type 4 960mA, the larger the arc will be.

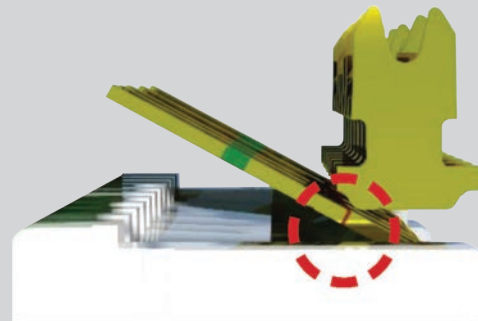

Substandard products or products not designed to allow for 802.3bt can lead to eventual failure of the products.

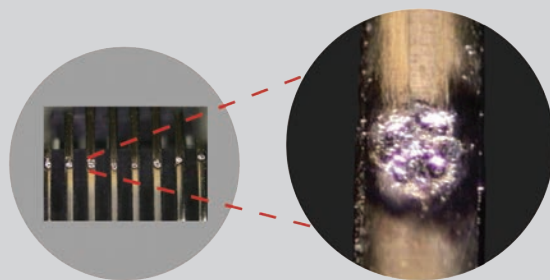

802.3BT COMPLIANCE

In order to be able to withstand the breaking currents associated with 802.3bt Type 3 and Type 4, products can be tested against IEC 60512-99-002 for compliance. The testing determines the ability of connectors to withstand a minimal number of engagements and separations when an electrical current is being passed through the connector. Without having this compliance certification the customer has no indication as to how many disconnection cycles the product will withstand before arcing damage causes the failure of the product.

DINTEK CAT.6 & CAT.6A PRODUCTS

HIGH PERFORMING AND 802.3BT TYPE 4 READY CABLE

POWERMAX™ CAT.6 & POWERMAX+™ CAT.6A

The DINTEK PowerMAX™ Cat.6 & PowerMAX+™ Cat.6A 4PPoE ready cabling solutions are guaranteed to exceed ClassE / ClassEA channel specifications as set down in International standards.

These two solutions comprise Category 6 & 6A component compliant cable, keystone jacks, patch panels, and patch cords. When combined with DINTEK's Category 6/6A cable, an end-to-end channel exists that maximizes data throughput and provides headroom for all future technologies operating beyond one Gigabit for Cat.6 & 10Gigabit for Cat.6A.

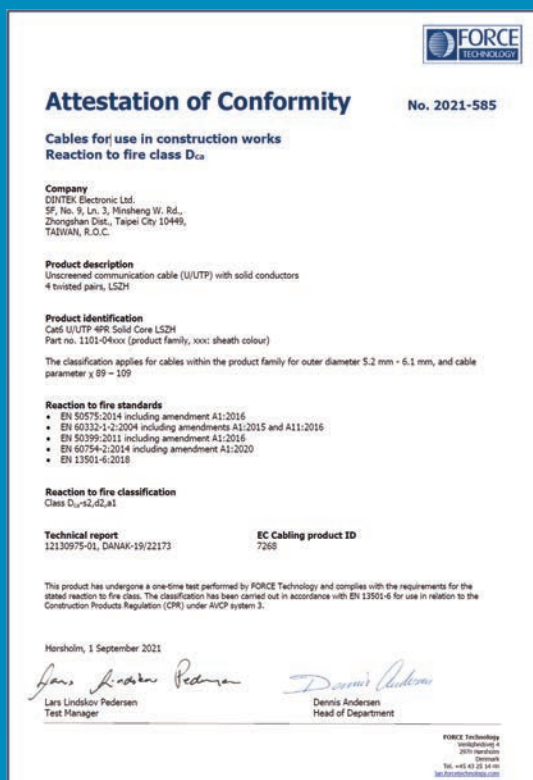

LETS LOOK AT THE FACTS

- DINTEK uses only solid copper conductors in all of its cables. We will not lower the quality of our product at the risk of the end users experience.
- DINTEK conductor sizes for Cat.6 and Cat.6A are set at 23AWG and 22AWG respectively. By keeping the gauge size of the conductor larger, there is less heat generation caused and less drop of voltage over distance. Cables simply perform better.
- DINTEK Cat.6 and Cat.6A exceed current ANSI/TIA and ISO Standards for performance.
- DINTEK Cat.6 and Cat.6A cabling is capable of handling the latest versions of power over Ethernet including IEEE 802.3-bt versions Type 3 & 4 without the need for derating, required for lower core sizes
- DINTEK Cat.6 23AWG Twisted Pair Cable has been tested over 500Mhz and has passed performance testing allowing 10Gbit Ethernet transmission up to a length of 70mtrs
- DINTEK Cat.6 & Cat.6A components have been certified as being IEEE 803.2bt 4PPoE Compliant.



DINTEK CAT.6 & CAT.6A PRODUCTS

4PPOE COMPLIANT & CERTIFIED CONNECTORS

POWERMAX™ CAT.6 & POWERMAX+™ CAT.6A ezi-JACK SOLUTION

The DINTEK ezi-TOOL™ system is an all-in-one punch down and wire trim process, design to assure even connections, better performance and faster fit off times.

The products in the ezi-TOOL system comprise 90degree and 180degree Cat5e and Cat6 & Cat6A modular keystone jacks.

The jacks work with either the ezi-TOOL or a standard 110 style DINTEK punch down tool, thus avoiding the need to have two different style of jacks.

FEATURES

- DINTEK Cat.6 & Cat.6A connector components have been certified as being IEEE 803.2bt 4PPoE Compliant.
- All-in-one Punch down and wire trim process
- Multi use ezi-JACK (Keystones), can be used in ezi-TOOL and also standard punch down tool
- E-Tool can be used for either Cat5e, Cat6 or Cat6A Keystone ezi-JACKS
- Jacks can be inserted either side of ezi-TOOL

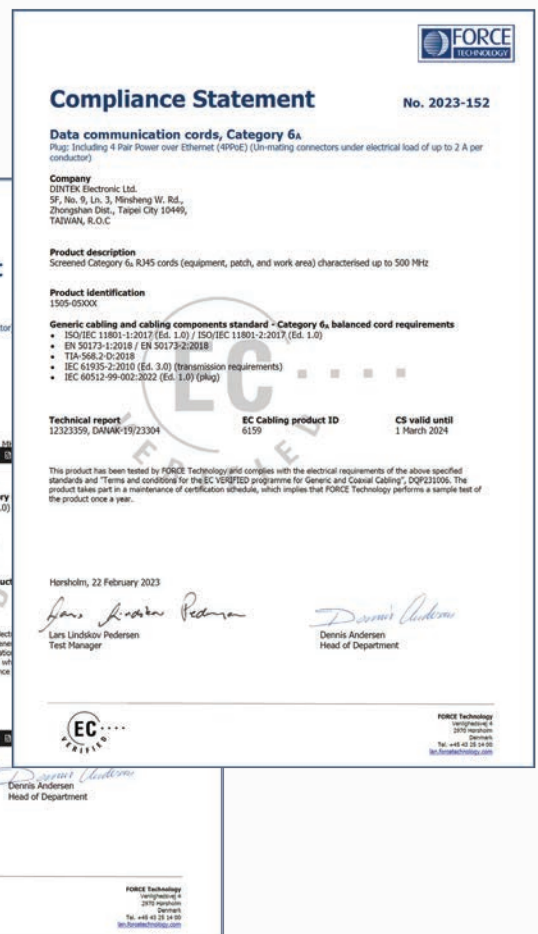
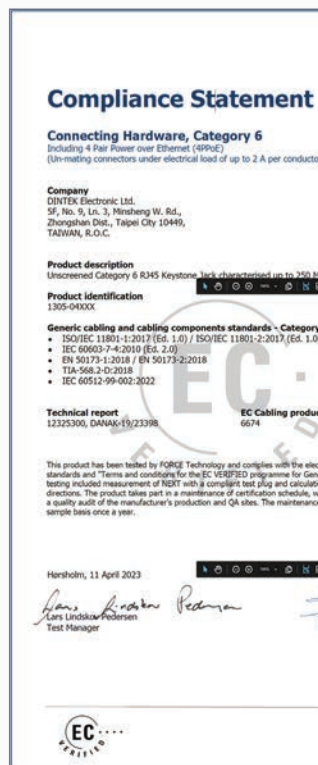

DINTEK CAT.6 & CAT.6A PRODUCTS

EZI-TOOL CRIMP AND CUT SOLUTION

Terminating the DINTEK PowerMAX500™ cabling onto ezi-JACKS using the ezi-TOOL system is an extremely quick process. From stripping the cable, placing wires into the jack and terminating using the tool, the entire process should only take an experienced technician approx 1 minute. Compared to a 2-3 minute termination time using the legacy 110 impacting tool, it is easy to see how the ezi-TOOL system can maximize profits on your jobs.

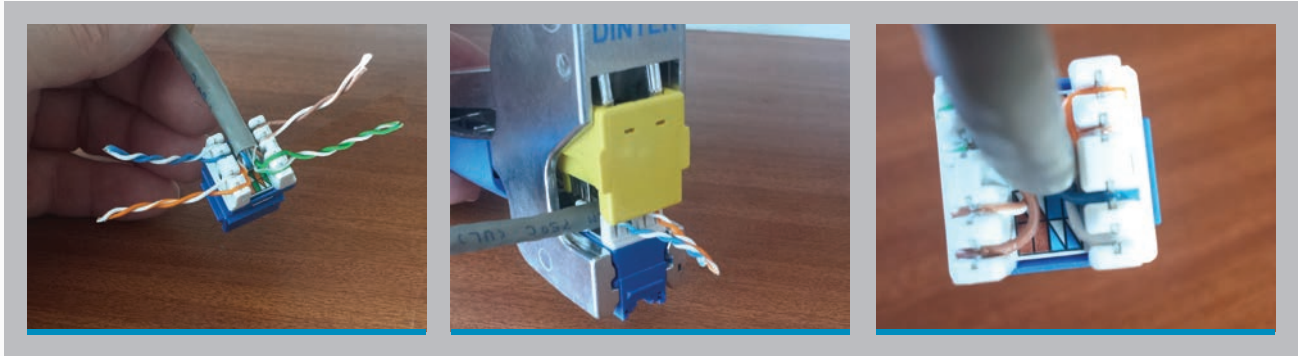

WIRE PLACEMENT

Place wires securely in IDC wire holders, keeping twists right up to the termination points

TERMINATE WITH EASE

Place ezi-JACK into tool, depress and the tool will crimp all wires evenly and trim excess wires off.

GAS TIGHT CONNECTION

The resulting termination is pushed through the IDC instead of impacted thus maintains gas tight connection

DINTEK VERTICAL & HORIZONTAL STYLE EZI-JACKS

COMPONENT
LEVEL
PERFORMANCE



VERIFIED TO
LATEST POE ++
96W STANDARD
60512-99-02

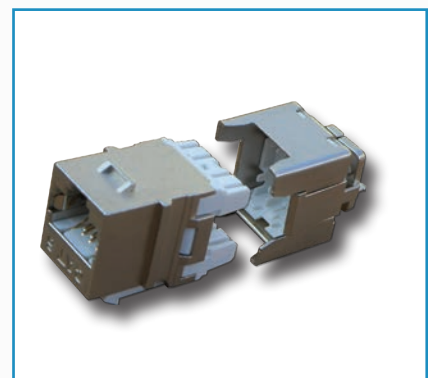

DINTEK Cat.6 & Cat.6A ezi-Jacks provide performance that exceeds ANSI/TIA & ISO connecting hardware performance specifications. They also ensure backwards compatibility with components and systems of lower performing categories. Combined with other DINTEK products, they are the perfect solution to your voice, data communications & PoE needs.

DINTEK CAT.6 & CAT.6A PRODUCTS

COMPLETING THE CHANNEL

POWERMAX500™ CAT.6 TWISTED PAIR RJ45 MODULAR PLUGS

The DINTEK Category 6 & 6A solutions are guaranteed to exceed ClassE/ClassEA channel specifications as set down in International standards.

In order to complete a channel link requires the use of high quality patch cords at either end terminating to the RJ45 outlet.

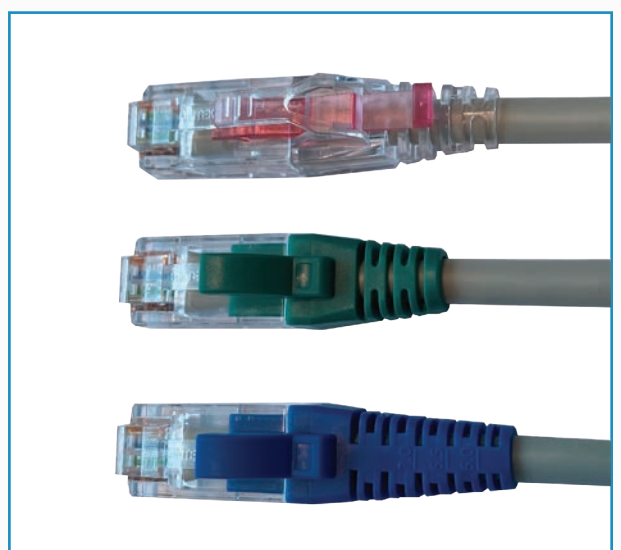
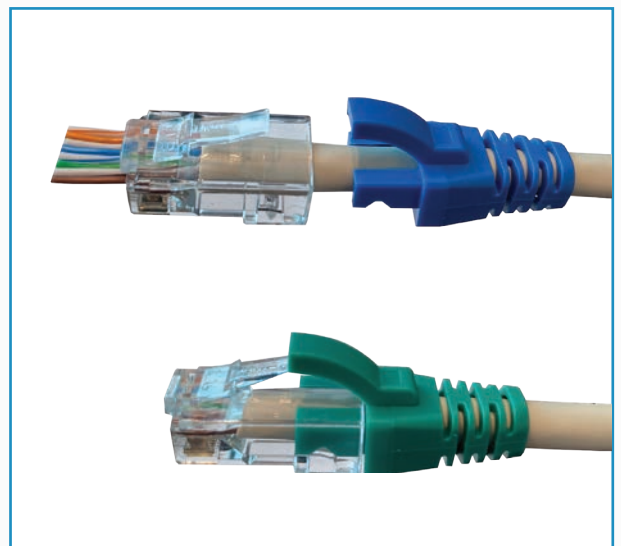
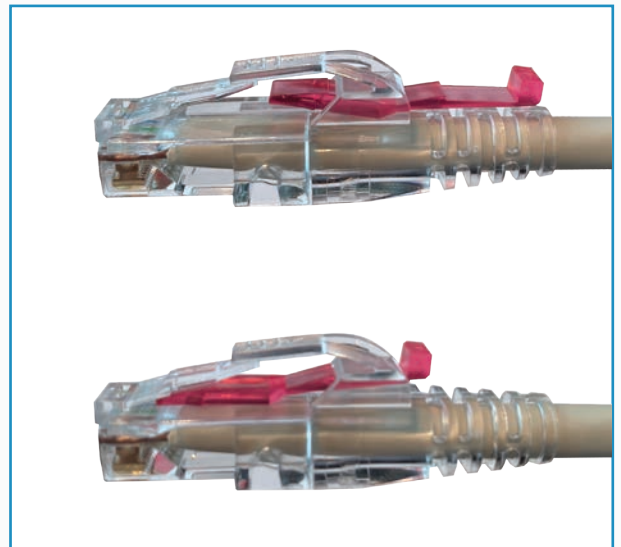

Not only does the connection need to provide low return loss and NEXT, but as it is the other side of the PoE connection it needs to be able to withstand disconnection currents up 960mA

DESIGNED WITH LOW RETURN LOSS AND NEXT PERFORMANCE



DINTEK CAT.6 & CAT.6A PRODUCTS

PRODUCT SPECIFICATION

Ordering Information		
DINTEK PowerMAX™ Category 6 Unshielded Solution		
Product Number	Product Name	Related Codes
1101-04044	PowerMAX500™ Cat.6 U/UTP 23AWG PVC Cable	
1101-04046	PowerMAX500™ Cat.6 U/UTP 23AWG LSZH Cable	
1305-04042	PowerMAX™ Cat.6 ezi-JACK Vertical Jack - White	1305-04049 - Black Cat.6 ezi-JACK Vertical Jack 1305-04065 - Blue Cat.6 ezi-JACK Vertical Jack 1305-04067 - Green Cat.6 ezi-JACK Vertical Jack 1305-04068 - Red Cat.6 ezi-JACK Vertical Jack 1305-04066 - Yellow Cat.6 ezi-JACK Vertical Jack
1305-04017	PowerMAX™ Cat.6 ezi-JACK Horizontal Jack - White	1305-04053 - Black Cat.6 ezi-JACK Horizontal Jack 1305-04031 - Blue Cat.6 ezi-JACK Horizontal Jack 1305-04034 - Green Cat.6 ezi-JACK Horizontal Jack 1305-04032 - Red Cat.6 ezi-JACK Horizontal Jack 1305-04033 - Yellow Cat.6 ezi-JACK Horizontal Jack
1406-00043	1U 24P UTP Snap-in Panel - Including 24 Black Jacks	
1402-04011	PowerMAX™ 1U 24P Cat.6 UTP Patch Panel	
1402-04012	PowerMAX™ 1U 48P Cat.6 UTP Patch Panel	
1201-04177	PowerMAX™ 1mtr Cat.6 UTP Patch Cord - PVC Gray	1201-04434- Black Cat.6 UTP Patch Cord - PVC 1201-04178 - Blue Cat.6 UTP Patch Cord - PVC 1201-04210 - Green Cat.6 UTP Patch Cord - PVC 1201-04209 - Red Cat.6 UTP Patch Cord - PVC 1201-04208 - Yellow Cat.6 UTP Patch Cord - PVC
1201-04179	PowerMAX™ 3mtr Cat.6 UTP Patch Cord - PVC Gray	1201-04332 - Black Cat.6 UTP Patch Cord - PVC 1201-04180 - Blue Cat.6 UTP Patch Cord - PVC 1201-04218 - Green Cat.6 UTP Patch Cord - PVC 1201-04182 - Red Cat.6 UTP Patch Cord - PVC 1201-04181 - Yellow Cat.6 UTP Patch Cord - PVC
1201-04183	PowerMAX™ 5mtr Cat.6 UTP Patch Cord - PVC Gray	1201-04231 - Black Cat.6 UTP Patch Cord - PVC 1201-04220 - Blue Cat.6 UTP Patch Cord - PVC 1201-04223 - Green Cat.6 UTP Patch Cord - PVC 1201-04222 - Red Cat.6 UTP Patch Cord - PVC 1201-04221 - Yellow Cat.6 UTP Patch Cord - PVC
1501-88060	PowerMAX™ RJ45 Pass-Through ezi-PLUG	
1505-04001	DuraMAX™ Cat.6 RJ45 Industrial STP Plug	
Ordering Information		
DINTEK PowerMAX+™ Category 6A Shielded Solution		
Product Number	Product Name	Related Codes
1105-06023	PowerMAX™+ Cat.6A U/FTP 23AWG PVC Cable - Gray	
1105-06025	PowerMAX™+ Cat.6A U/FTP 23AWG LSZH Cable - Gray	
1305-05010	PowerMAX™+ Cat.6A ezi-JACK Shielded Jack	
1305-05017	PowerMAX™+ Cat.6A Toolless Shielded Jack	
1406-00012	PowerMAX™+ 1U 24P Cat.6A FTP Snap-in Panel	
1406-00032	PowerMAX™+ 0.5U 24P Cat.6A FTP Snap-in Panel	
1201-06033	PowerMAX™+ 1mtr Cat.6A S/FTP Patch Cord - PVC - Gray	1201-06096 - 1mtr - S/FTP - LSZH Cat.6A Patch Cord 1201-06091 - 1mtr - F/UTP - LSZH Cat.6A Patch Cord
1201-06034	PowerMAX™+ 3mtr Cat.6A S/FTP Patch Cord - PVC - Gray	1201-06098 - 3mtr - S/FTP - LSZH Cat.6A Patch Cord 1201-06093 - 3mtr - F/UTP - LSZH Cat.6A Patch Cord
1201-06035	PowerMAX™+ 5mtr Cat.6A S/FTP Patch Cord - PVC - Gray	1201-06099 - 5mtr - S/FTP - LSZH Cat.6A Patch Cord 1201-06095 - 5mtr - F/UTP - LSZH Cat.6A Patch Cord

DINTEK Electronic Limited

N511, 5F, 2nd Bldg, No. 96, Sec. 2, Zhongshan N. Rd.
Zhongshan Dist., Taipei City 10449, Taiwan (R.O.C.)

TEL: +886-2-25223138

www.dintek.com.tw

E-Mail : sales@dintek.com.tw

